

Data Acquisition (DAQ) Operations Manual



Super Systems Inc
7205 Edington Drive
Cincinnati, Ohio 45249
513-772-0060/800-666-4330
Fax: 513-772-9466
www.supersystems.com

Table of Contents

Overview	3
SSi DAQ Wiring Diagram	4
SSi DAQ Setup.....	5
Step 1 – Install Configurator 2.0 on the Local Computer	5
Step 2 – Connect the SSi DAQ to a Network or Local Computer	7
Step 3 – Configure Configurator 2.0 on the local computer.....	8
Step 4 – Complete Configurator Range Setups Menu Option.....	9
Step 5 – Complete Configurator Input Offsets Menu Option.....	10
Analog Inputs.....	11
Adding a Jumper to an Input.....	11
Thermocouple connections.....	11
Voltage connections	11
4 – 20 mA. Current Loop connections	12
Setting the DIP switches to Assign Board Numbers	12
Configurator Menu	13
Input Values	13
Aux Instruments.....	14
Communication Setup.....	15
Device Configuration.....	17
Range Setups.....	18
Input Offsets.....	19
Aux Instrument Setup.....	20
Custom Curves	21
Calibration	22
Zero/Span Calibration	22
Cold Junction Offset	23
Satellite Boxes – SR3, SR6.....	24
DAQ Data Sheets.....	25
Appendix 1 – Input Number Table.....	27
Appendix 2 - Input Ranges	28
Revision History.....	29

Overview

The SSI DAQ data acquisition module is a simple, powerful and expandable product for measuring a vast array of signals in the process control environment. The DAQ can be used with as few as 3 inputs and can be expanded to as many as 48 per DAQ depending upon your needs. Each SSI fully-isolated 3 input analog module can be configured on an input-by-input basis for a range of voltage inputs from as little as 20 mV to as much as 10V or for a 4 - 20 mA current signal. Communications to the DAQ are available via Modbus serial protocol or through the DAQ's Ethernet port via ModbusTCP. Calibration and configuration are available through SSI's Configurator software (provided) and the DAQ also features a limited web server for simple interfacing from any PC in your plant (Ethernet communications required).

SSi DAQ Wiring Diagram

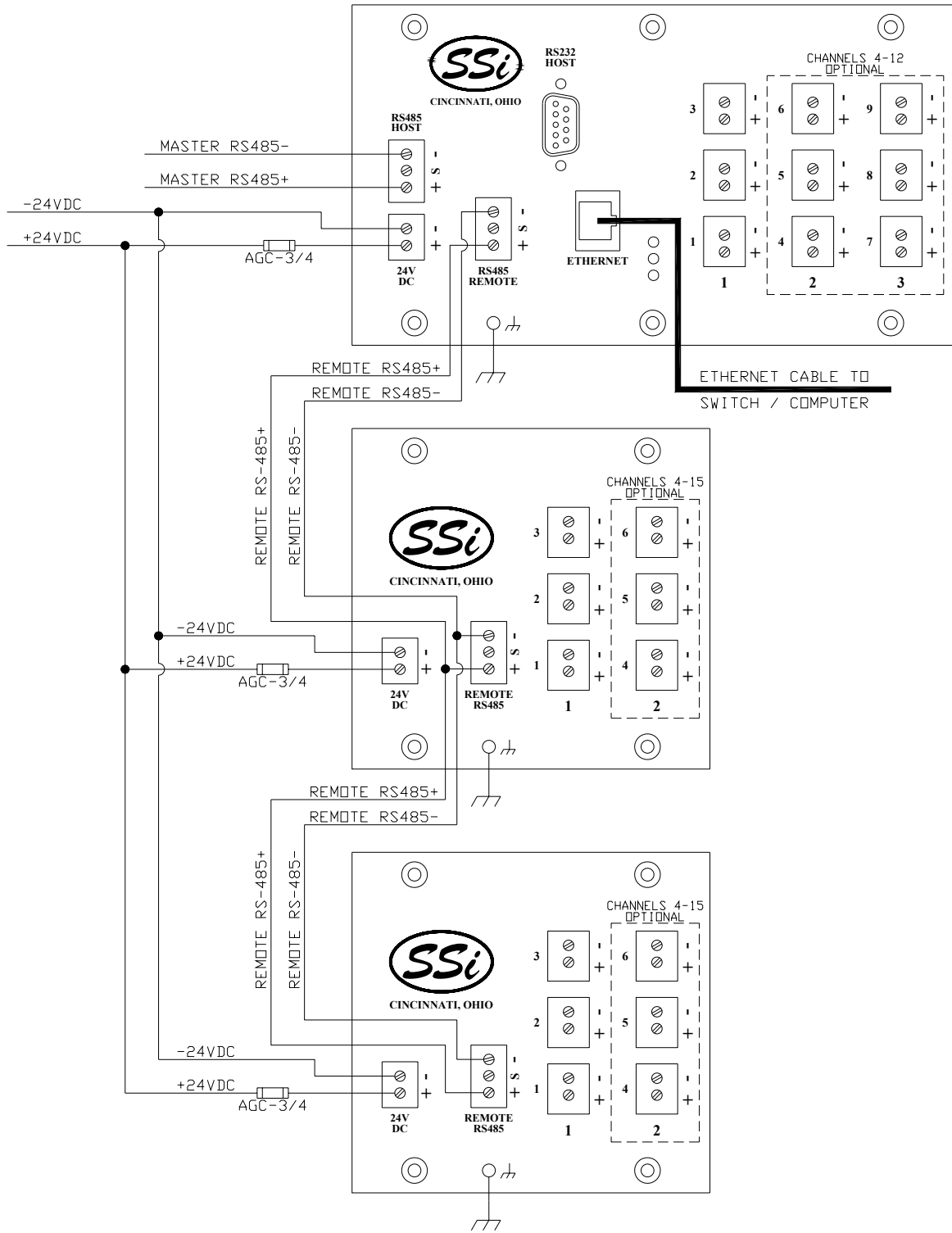

SSi DAQ Setup

This section will explain how to set the SSi DAQ up. The steps required to set up the SSi DAQ through a local computer are:

1. Install Configurator 2.0 on the local computer
2. Connect the SSi DAQ to a network or local computer
3. Configure Configurator 2.0 on the local computer
4. Complete Configurator *Range Setups* menu option
5. Complete Configurator *Input Offsets* menu option

Step 1 – Install Configurator 2.0 on the Local Computer



Configurator 2.0 is a configuration utility developed by SSi that will allow the user to interface with an SSi instrument directly or over a network. The installation file, ConfiguratorSetup.msi, should be included with the installation CD

provided by SSi. If this file is not on the CD, contact Super Systems at 513-772-0060.

Double-click on the installation file to begin the installation process.

The first page displayed is just for information purposes. Click on the **Next >** button to move to the next page, or press the **Cancel** button to cancel the installation.



The second page is a warning about Configurator 2.0. Since Configurator 2.0 is a Microsoft .Net 2.0 product, the local computer will have to have the .Net 2.0 framework installed before Configurator 2.0 can be used. Click on the **Next >** button to continue or the **Cancel** button to cancel the installation.



Page 3 will allow the user to select the location of the installation. The default location is "C:\SSi\". To change this location, click on the **Browse** button and select a new location from the dialog box that is displayed. The **Disk Usage** button is a utility that will display the available hard drive space on the local computer. Click on the **Next >** button to move to the next page.



Page 4 will allow the user to review the installation settings, if necessary. Click on the Install button to install the software.

Page 5 will display a progress bar as the installation proceeds. *Note: The installation should only take a few minutes.*

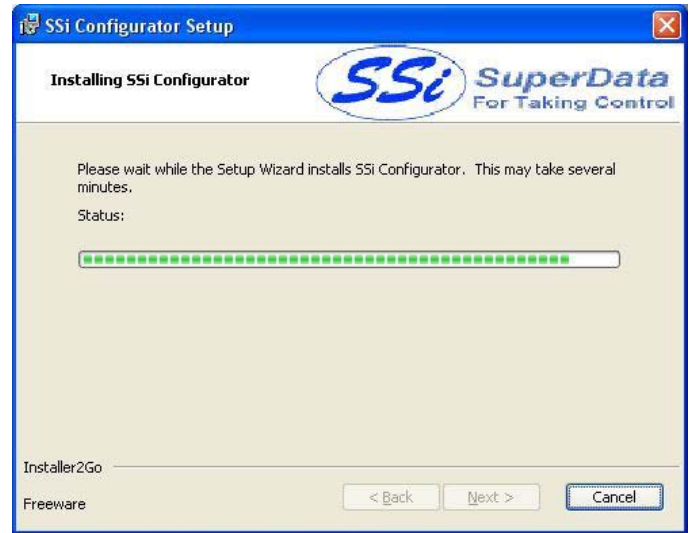

Page 6 is the finishing screen, which is displayed after the software has been installed. Click on the **Next >** button to continue.



Page 7 is the informational screen about the makers of the installation software. Click on the Finish button to close out this screen.

Step 2 – Connect the SSI DAQ to a Network or Local Computer

To connect the instrument to the network, through a wall port or switch, use a regular Ethernet cable. To connect the instrument directly to a computer, use an Ethernet crossover cable. Contact your IT Department for the necessary cables. Once the DAQ is connected to a network, the Configurator 2.0 software will be able to find it during any searches. Connecting the instrument to your network or directly to a PC is accomplished using the Ethernet port on the instrument. If you are connecting the instrument to your network, you will need an Ethernet cable. The cable is plugged into the instrument Ethernet plug and then other end should be plugged into a network hub. If the IP Address of the instrument needs to be changed, this can be done through the Configurator software (see Step 3 below). If you are not putting the instrument on the network, you should use an Ethernet crossover cable.

Ethernet crossover cables are most often used when connecting two Ethernet computers without a hub. An Ethernet crossover cable has its send and receive wires crossed. When using a hub or switch, this is automatically done for you. With a crossover cable, you are forming a network between the computer that you are directly plugged into and the SSI DAQ. There will be some network settings on the computer that you will have to configure for the 2 devices to communicate. The DAQ will have the network setting already setup with a default IP address – normally supplied by the customer. This can be modified through the Configurator software. Network settings can be found through the *Control Panel* in Microsoft Windows. By selecting *Network Setting*, the operator will be given a list of the current available connection types. Using the crossover cable will require the “Local Area Connection” as seen in the diagram to be modified. The Properties can be changed by highlighting the connection and using the right mouse button to click and select the *Properties* tab or by highlighting the connection and clicking on Change setting of this connection. Once the *Local Area Connection Properties* screen is displayed, highlight the Internet Protocol (TCP/IP) option. Click the Properties button to display Internet Protocol (TCP/IP) Properties. On the Internet Protocol (TCP/IP) Properties tab, you will need to select the option for Use The Following IP Address.

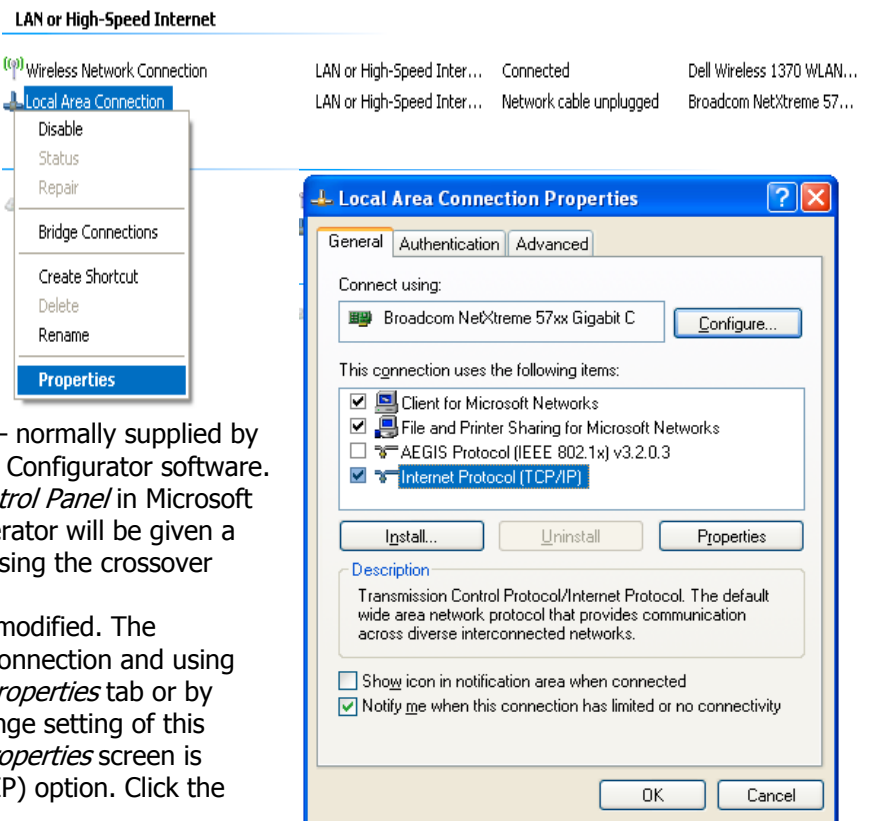

Enter in the following data on these fields:

IP Address: 192.168.0.209

Subnet Mask: 255.255.255.0

Default Gateway: 192.168.1.1

Note: These fields are suggestions. Contact your IT department to get a valid IP address, Net Mask, and Gateway for the local computer.

To change the network settings on your computer you may need addition information so please refer to the computer manual.

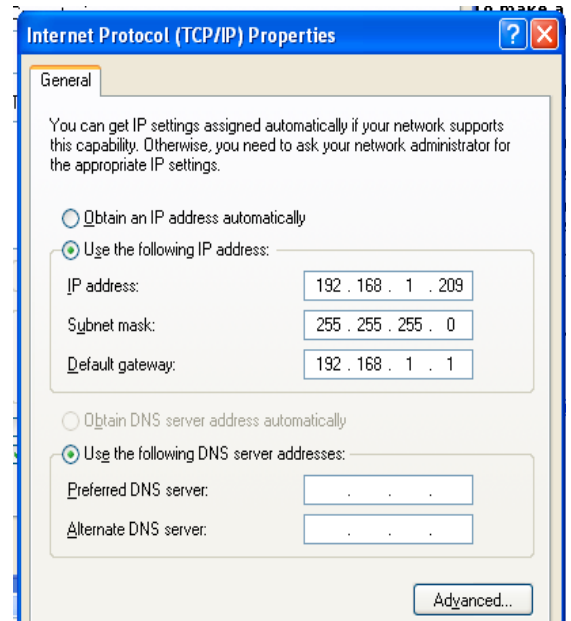

Step 3 – Configure Configurator 2.0 on the local computer

When Configurator starts up for the first time, the user will see the main screen, which will be blank because no instruments have been set up yet. The first step is to set up an instrument in Configurator.

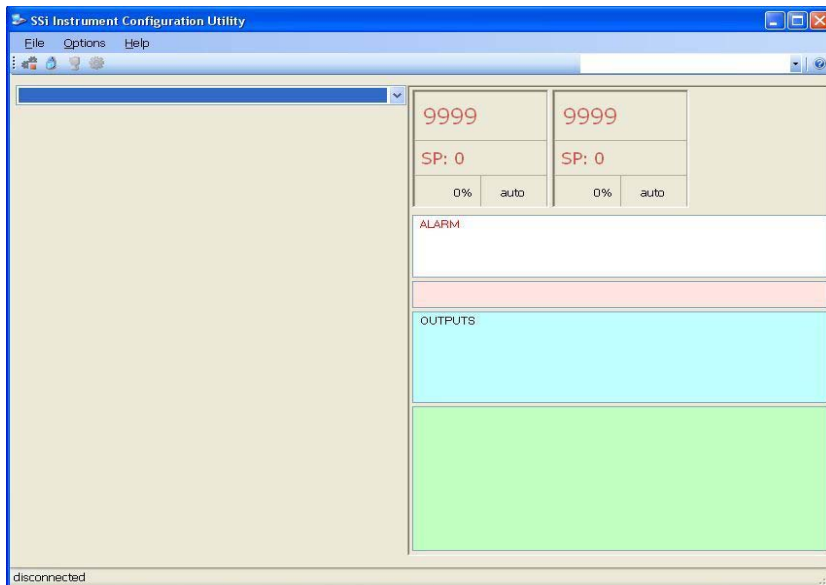

Management screen.

First, the user will need to log in with administrative rights. *Note: The user will need to be logged in with at least administrative rights; Supervisor rights will not allow the user to add an instrument.* The four levels of rights in Configurator are: operator, supervisor, administrator, SSI Special. The lock on the toolbar will let the user know what level is currently logged in. Operators are blue, supervisors are gold, administrators are green, and the SSI Special, which is used for configuration purposes before the unit is shipped, is red. Click on the lock and log in with the following information: username = administrator, password = 2. *Note: The supervisor and administrator passwords can be changed on the Furnace Setup menu page.* The lock should now be green. Click on the *Options* menu, then select *Settings*. This will display the *System*

Click on the **Add** button to display the rest of the screen. First, give the instrument a name. The name can be anything the user wants, but it is suggested that the user makes the name descriptive. Next, select the model from the drop-down list. For the DAQ, the model number is "9021". Next, enter the IP address in the "Ethernet" section and make sure the "Ethernet" option is selected. *Note: The SSI DAQ is shipped with an IP address supplied by the customer. Note: even if the local computer is hooked up directly to the instrument through a crossover cable, the IP address will still need to be correct.* The user can also scan the network to find all available SSI instruments by clicking on the search button next to the "Ethernet" IP address box. This will set up Configurator for Ethernet communications. To set it up for serial or SuperData communications, the proper option will need to be selected and filled out.

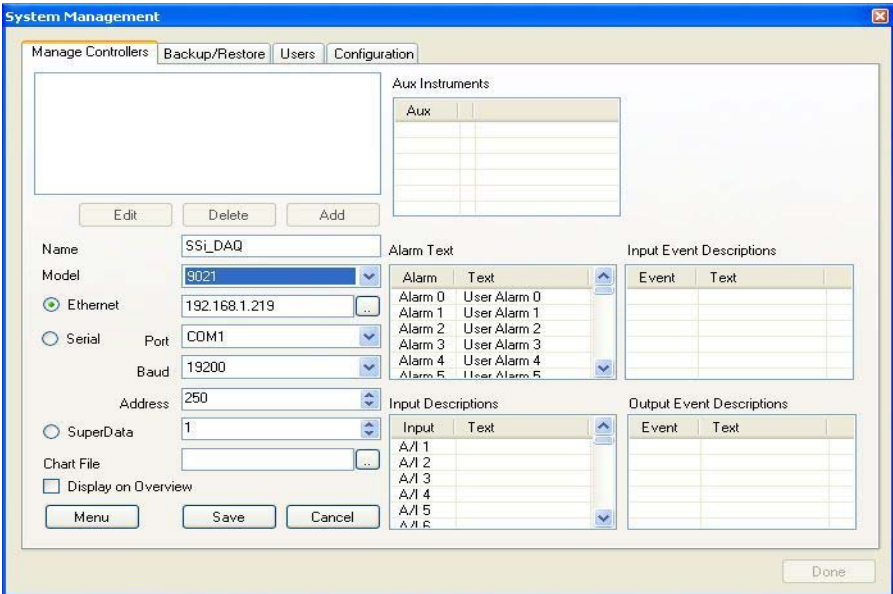

The DAQ has RS-232 host communications and RS-485 host communications capability (shown below). To set the DAQ up for serial communications, the user will need to know which COM port will be used. Select that COM port (**COM 1 – COM 20** is available). The Baud rate can be left at the default – **19200**. The address should be changed to **1**. If the user is using RS-232 communications, or if the DAQ is the only device on RS-485 communications, then the address of **250** will be sufficient. Click on the **Save** button to save the information. Click on the **Done** button to close down this screen.



The device can now be selected from the drop-down list on the Configurator main screen.

Step 4 – Complete Configurator Range Setups Menu Option

Note: This menu item is also located later in the manual under the Configurator Menu section.

The **Range Setups** menu option will allow the user to view/modify the selected input ranges for each of the three inputs on a board. The user will also be able to view/modify the input linearization for each input per board. There are a maximum of sixteen boards.

The **Input Type** can be one of the following:

- B** **T**
- C** **2.5 V**
- E** **1.25 V**
- J** **160 mV**
- K** **80 mV**
- N** **40 mV**
- NNM** **20 mV**

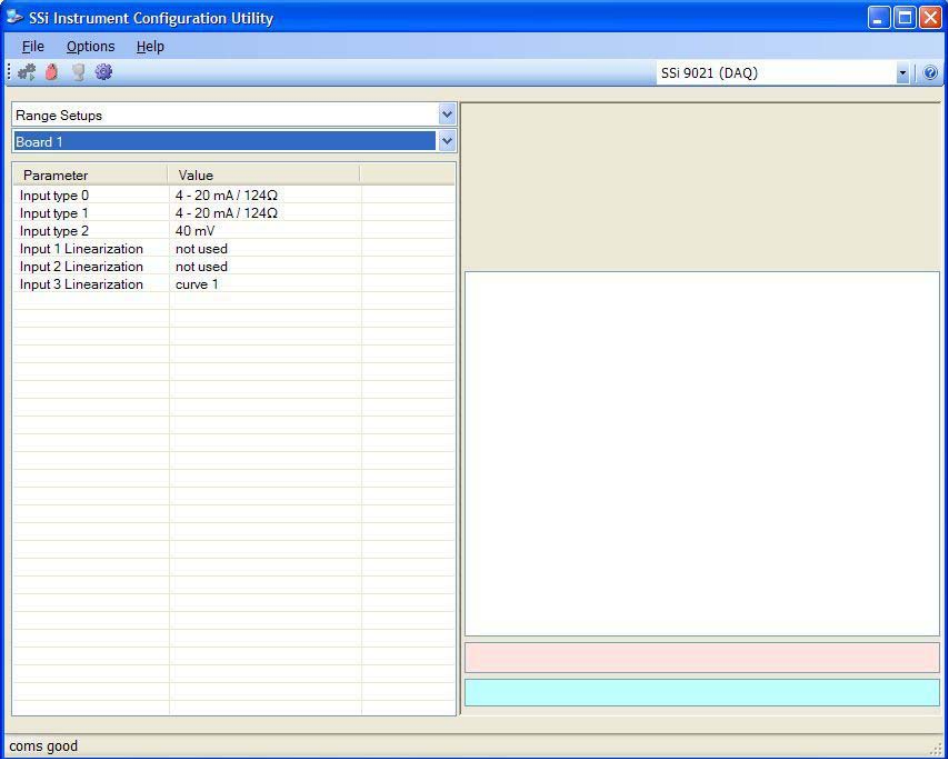

Analog Inputs

The Super Systems, Inc. Part Number 31575 Analog Board contains a group of three channels isolated from the main DC power source. Each input is fully isolated. The board can be connected to thermocouples, voltage sources from 20mV full scale to 1.28 Volts full scale, voltage sources from 0 V full scale to 10 V DC full scale, or 4 – 20 mA current loops.

Adding a Jumper to an Input

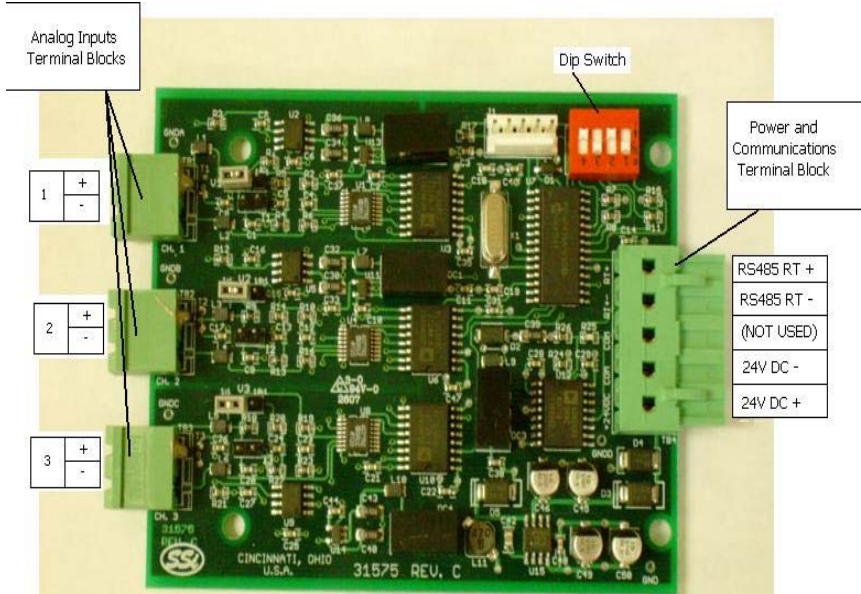

When measuring a 4-20mA current signal or a voltage signal, such as a thermocouple, a jumper must be placed on the corresponding two or three-position header. For example, Input 1 would need to have a jumper placed between the pins labeled "I1" before connecting a 4-20mA signal. Failure to add the jumper will result in damage to the circuit board. The jumper may already be present at each of the three headers, but unless it is attached across both pins (not just one) it will not be connected.

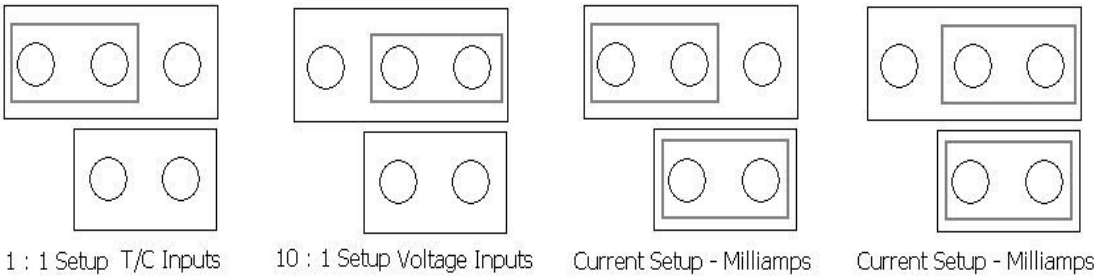

Thermocouple connections

Thermocouple wires can be connected directly to the terminal blocks. The thermocouple junctions should not be grounded. If they do touch a ground reference, all thermocouples on a board must have a common ground reference. If multiple thermocouples are connected to different ground reference points, the accuracy of all thermocouples on the board cannot be guaranteed to be accurate. When setting up a voltage input signal, such as a thermocouple input or any voltage input signal up to 1.28 volts, the jumper must be placed on the pins in the 1:1 setup (left diagram).

Voltage connections

Voltages from 0 mV to 10 Volts DC can be directly connected to the terminal blocks. When measuring ground-referenced voltages, all references must share a common ground reference. If the voltage sources are connected to different ground reference points, the accuracy of all the voltage sources connected to the board need to be checked for accuracy. **Since higher voltages can damage the input board, any voltage input signals, such as a vacuum gauge, must have the jumpers placed on the pins in the 10:1 setup (middle diagram).** This will insure that any signal going into the board will be scaled down so it will not damage the input board.

4 – 20 mA. Current Loop connections

Before connecting the current loop, insert the shorting jumper on the board for each channel used to measure current loops. This jumper inserts the 62-ohm shunt resistor across the input of the A/D. If multiple current loops are connected to one board, all must share the same power supply and ground reference points or the accuracy of all the current loops need to be checked for accuracy. When setting up a current input signal, such as a 4 – 20 mA signal, the jumper must be placed on the pins in the current setup (right diagram). Notice that there is also a jumper set up in the 1:1 setup only when inputting a current signal. This is because current signals also have a corresponding voltage signal.

Warning: Connecting a mA input without the Input Jumper will damage the input.

To add a jumper to an input:

1. Power down the unit.
2. Remove the thermocouple connector and the Ethernet cable from the DAQ.
3. Remove the top plate of the DAQ by unscrewing the screws around the top of the DAQ.
4. Grasping both sides of the input board, carefully pull the input board out of the DAQ and set the jumper for the appropriate set of pins, i.e. "V1" for input 1, "V2" for input 2, etc. A jumper will need to be set – placed on both pins – to be considered "on". Slide the input board back into the DAQ slot.
5. Replace the top plate of the DAQ by screwing in the screws around the top of the DAQ.
6. Re-connect the Ethernet cable and thermocouple connector.

Setting the DIP switches to Assign Board Numbers

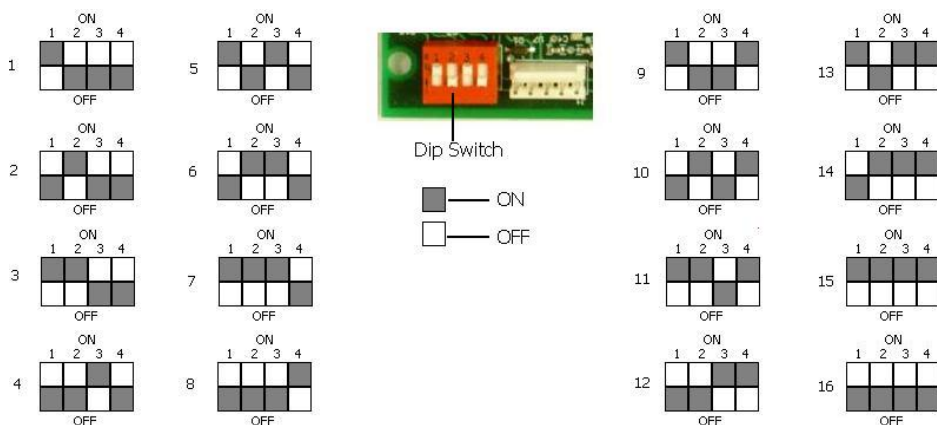

Each input board, whether directly connected in the DAQ or connected through a satellite box, must have a unique address assigned by the DIP switches on each input board. A unique address will ensure that the DAQ will correctly read all of the boards set up. If two or more boards have the same address, multiple errors could occur such as: DAQ reading data from one board one second, then reading data from another board the next second, no data being read from the DAQ, etc. *It is important that each board has a unique address.* Each

DIP switch has four switches on it labeled: 1, 2, 3, and 4. These numbers follow a binary numbering system – i.e. 1 = 1, 2 = 2, 3 = 4, and 4 = 8. There is an ON and an OFF position for each switch. OFF = 0 and ON = 1. Each board number can be assigned by setting the appropriate switches to ON. For example, to set a board number to 1, set the "1" switch to ON and the "2", "3", and "4" switches to OFF ((1*1) + (2*0) + (4*0) + (8*0) = 1). To set the board number to 10, set the "1" and "3" switches to OFF and the "2" and "4" switches to ON ((1*0) + (2*1) + (4*0) + (8*1) = 10). *Note: Turning all switches to the off position sets the board to address 16.*

Configurator Menu

Input Values

Parameter	Value
[B1 OK 315.8]TC 1	3214.5
TC 2	1.2799
TC 3	3214.5
[B2 OK 324.9]TC 4	1.2799
TC 5	1.2799
TC 6	1.2799
[B3 OK 334.1]TC 7	2501.9
TC 8	2501.9
TC 9	2501.9
[B4 OK 311.5]TC 10	2501.9
TC 11	2501.9
TC 12	2501.9
[B5 OK 325.8]TC 13	2501.9
TC 14	2501.9
TC 15	2501.9
[B6 Bad 327.7]TC 16	-3264.0
TC 17	-3264.0
TC 18	-3264.0
[B7 Bad 273.1]TC 19	-3264.0
TC 20	-3264.0
TC 21	-3264.0
[B8 Bad 280.2]TC 22	-3264.0
TC 23	-3264.0
TC 24	-3264.0
[B9 Bad 287.3]TC 25	-3264.0
TC 26	-3264.0
TC 27	-3264.0
[B10 Bad 272.8]TC 28	-3264.0
TC 29	-3264.0

The *Input Values* menu option will display the current values of the inputs for each board up to sixteen boards, with three inputs per board. This screen is a read-only screen. See *Appendix 1 – Input Number Table* for a description on the input numbering.

Aux Instruments

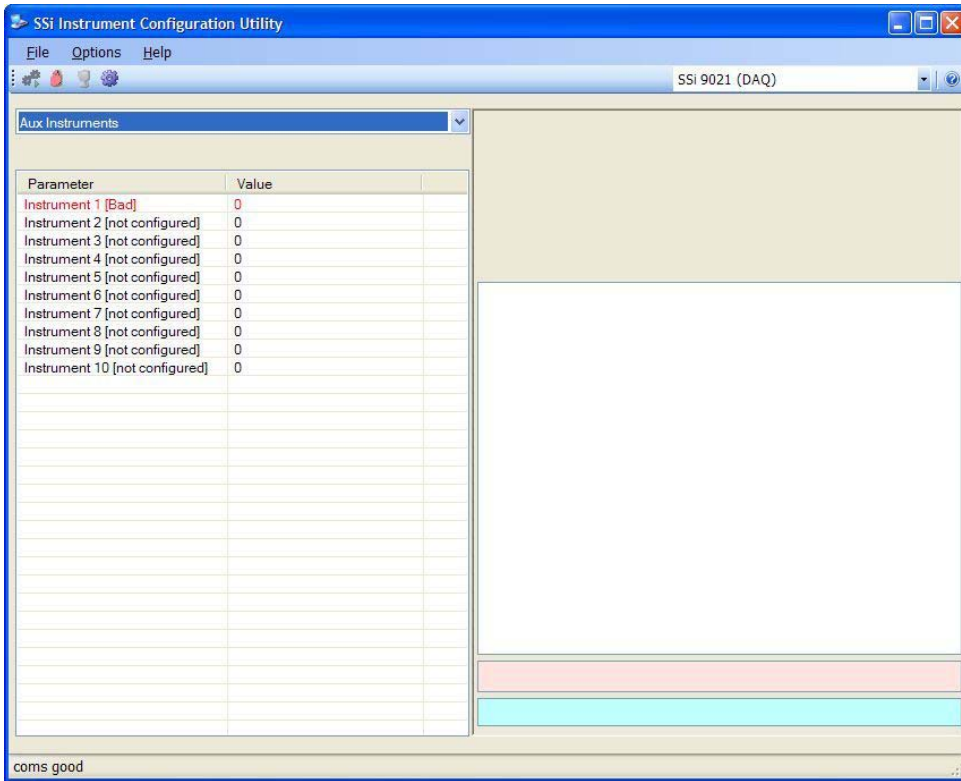

The *Aux Instruments* menu option will display the auxiliary instruments and their current values (if configured). This screen is a read-only screen. See the *Aux Instrument Setup* section for information on setting up an auxiliary instrument.

Communication Setup

The *Communication Setup* menu option will allow the user to set up the communications parameters for the DAQ.

Host 232 Baud

This option will allow the user to set the Host 232 baud rate. The options are:

1200
2400
4800
9600
14400
19200
28800
38400
57600
76800
115200

Slave 232 Baud

This option will allow the user to set the Slave 232 baud rate. The options are:

1200 **19200** **115200**
2400 **28800**
4800 **38400**
9600 **57600**
14400 **76800**

Host 485 Baud

This option will allow the user to set the Host 485 baud rate. The options are:

1200 **19200** **115200**
2400 **28800**
4800 **38400**
9600 **57600**
14400 **76800**

Host 485 Address

This option will allow the user to set the Host 485 address. The range is **1** through **249**.

Slave 1 (5,6) Baud

This option will allow the user to set the Slave 1 baud rate. The options are:

1200 **19200** **115200**
2400 **28800**
4800 **38400**
9600 **57600**
14400 **76800**

Slave 1 (5,6) Mode

This option will allow the user to set the Slave 1 mode. The options are: **Modbus** or **Modbus Host**

IP Address/IP Mask/IP Gateway

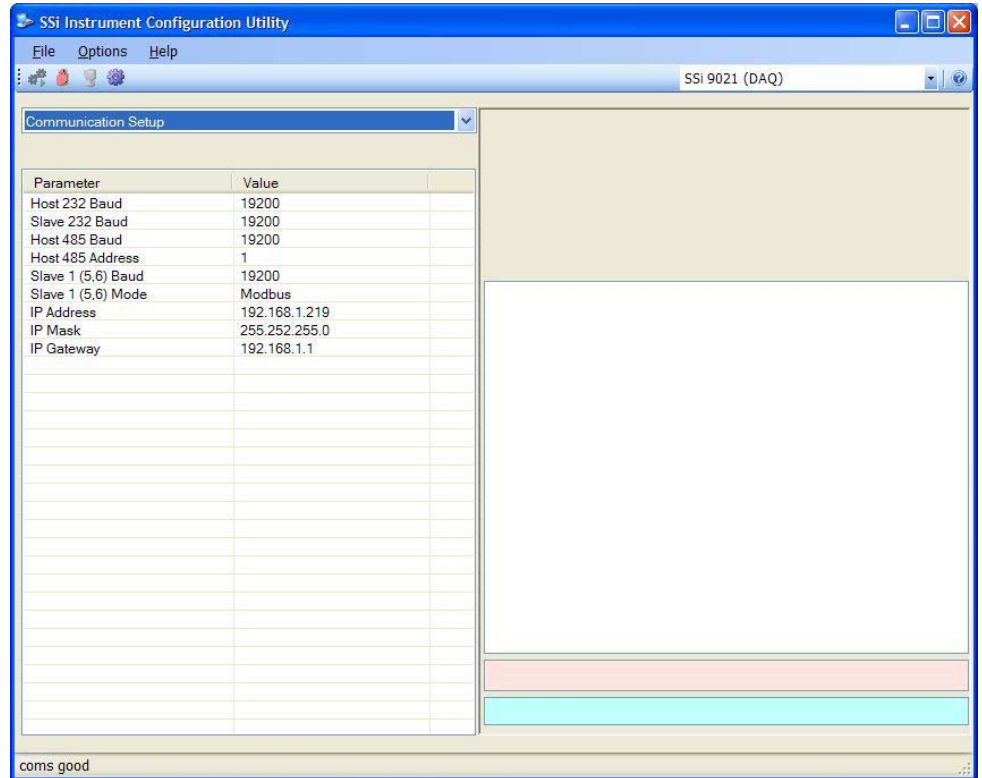

These options will allow the user to change the various IP addresses of the DAQ. Contact Super Systems Inc at 800-666-

4330 or your IT department for help in changing any of these addresses. *Note: Once the IP address has been changed, communications with the DAQ will be lost until the correct IP address is entered on the System Management screen (Step 3 – Configure Configurator 2.0 on the local computer section above).* Clicking on any of these options will allow the user to change all of the options at once.

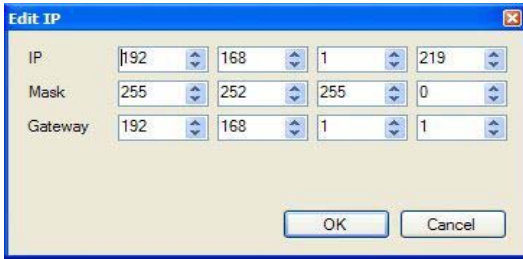

The image shows a Windows-style dialog box titled "Edit IP". It contains three rows of settings, each with four spinners. The first row is labeled "IP" and has values 192, 168, 1, and 219. The second row is labeled "Mask" and has values 255, 252, 255, and 0. The third row is labeled "Gateway" and has values 192, 168, 1, and 1. At the bottom of the dialog are "OK" and "Cancel" buttons.

Field	Value 1	Value 2	Value 3	Value 4
IP	192	168	1	219
Mask	255	252	255	0
Gateway	192	168	1	1

Range Setups

The *Range Setups* menu option will allow the user to view/modify the selected input ranges for each of the three inputs on a board. The user will also be able to view/modify the input linearization for each input per board. There are a maximum of sixteen boards.

The **Input Type** can be one of the following:

B	T
C	2.5 V
E	1.25 V
J	160 mV
K	80 mV
N	40 mV
NNM	20 mV
R	4-20 mA/124Ω
S	4-20 mA/62Ω

The **Input Linearization** can be one of the following:

- Not Used**
- Curve 1**
- Curve 2**
- Curve 3**
- Curve 4**
- Curve 5**
- Curve 6**
- Curve 7**

The "Input linearization" field is where the user can apply a specific curve, created with the menu option *Custom Curves*, to the input. To apply the curve, select the applicable curve, 1 through 7, from the drop-down list for the selected input.

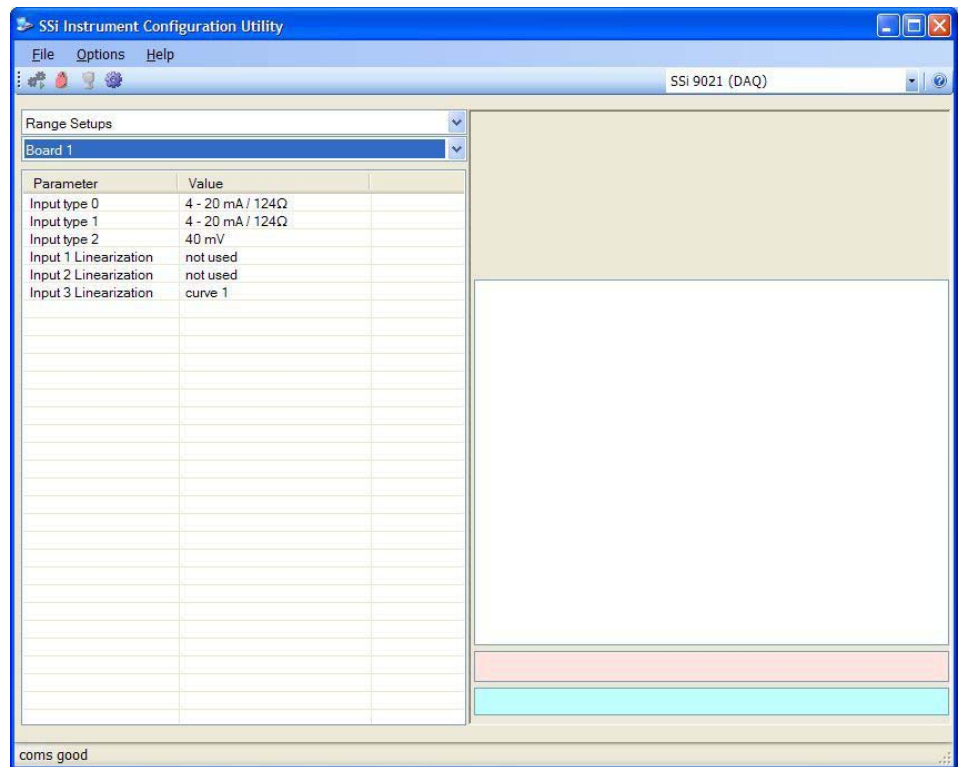

Input Offsets

The *Input Offsets* menu option will allow the user to enter an offset for each of the three inputs per board. There can be a maximum of sixteen boards. The offset can be within the range of **-32768** to **32767**. *Note: The decimal place will be dependent on the input type selected from the Range Setups menu.*

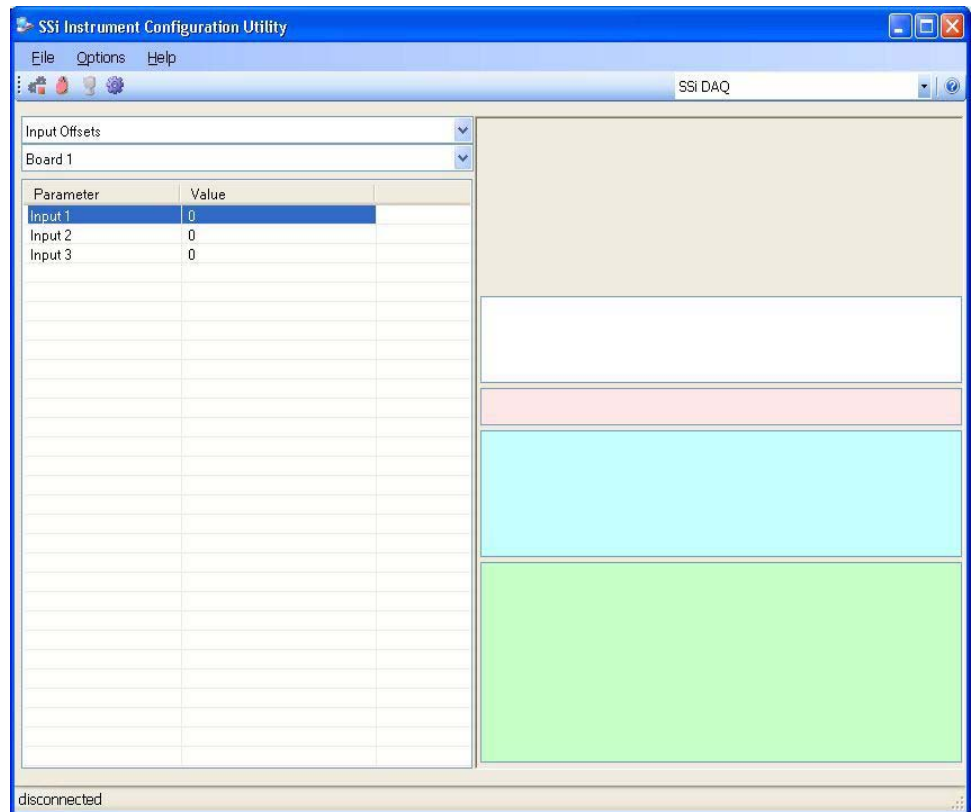

Aux Instrument Setup

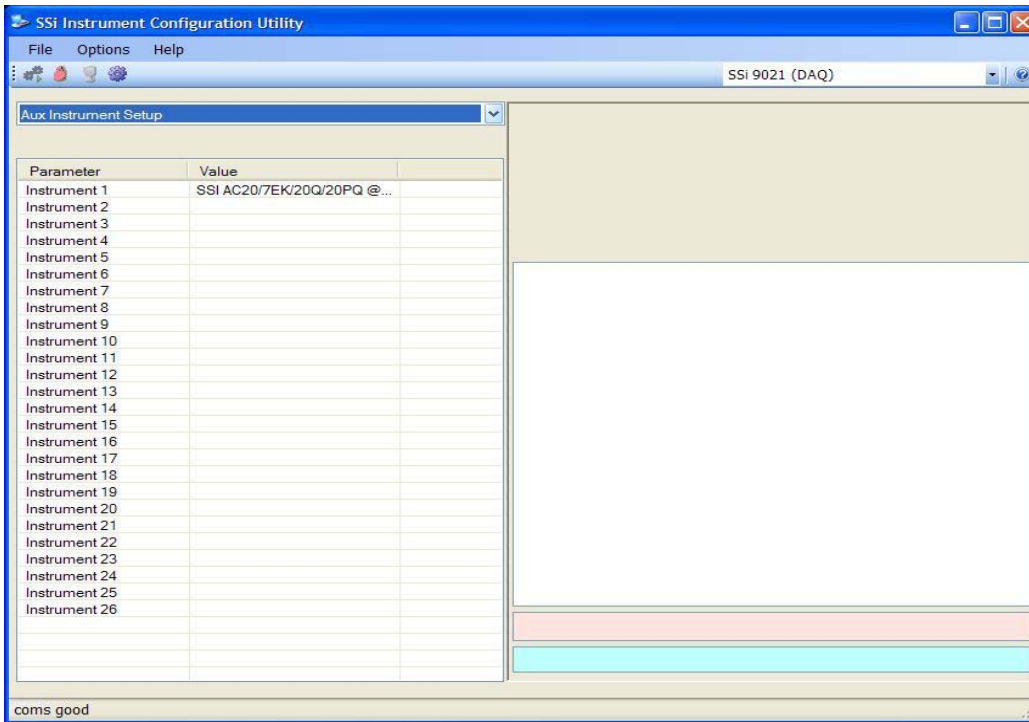

The *Aux Instrument Setup* menu option will allow the user to set up the auxiliary instruments for the DAQ. This screen will list the instruments available for setup, and any configurations set on the instruments.

Instrument

The list of available instruments are:

SSI AC20/7EK/20Q/20PQ

SSI 7SL

9200 LP 1

9200 LP 2

9200 LP 3

AE Flow_Meter

Eur 2404, E2704 LP1

Eur 2500 LP 1

Eur 2500 LP 2, E2704 LP 2

E2704 LP3

UDC 3300

Yoko UT320, UT350

Yoko UP350

Yoko 550 LP 1, 750 LP 1

Yoko 550, 750 LP 2

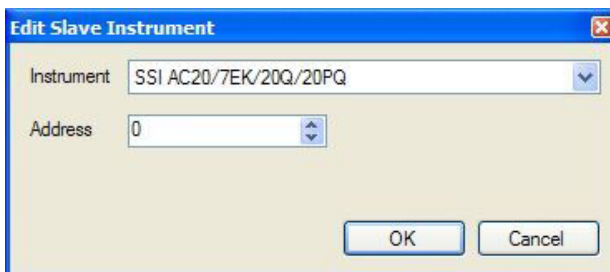

Address

The address can be **0** to **249**. *Note: An address of 0 disables the slave instrument on the DAQ.*

Note: There are twenty-six auxiliary instruments to set up on this menu screen, but only ten auxiliary instruments listed on the Aux Instruments menu screen. Starting with aux instrument 11, the values for the aux instrument begin taking up the internal memory locations of the input boards, starting with board 16: Aux instrument 11 replaces board 16; aux instrument 12 replaces board 15, etc.

Custom Curves

The *Custom Curves* menu option will allow the user to set up the variables for the curves. Curves are applied when the user wants to use a non-linear compensation to the input, such as in vacuum areas.

There are a maximum of seven curves.

The **Interpolation Type** can be one of the following:

None
Linear

The **mV 1** through **mV 32** can be within the range of **-32768** to **32767**.

The **Offset 1** through **Offset 32** can be within the range of **-32768** to **32767**.

Note: This is where the user will create the custom curve that can be applied to the inputs through the Range Setups menu option. See the Range Setups section for information on how to apply a curve to an input.

An example of a non-linear curve is for a 0 to 1V span (0 to 1000 mV). If the mV is 0, then the offset is 0. If the mV is 200, then the offset is 400, etc.

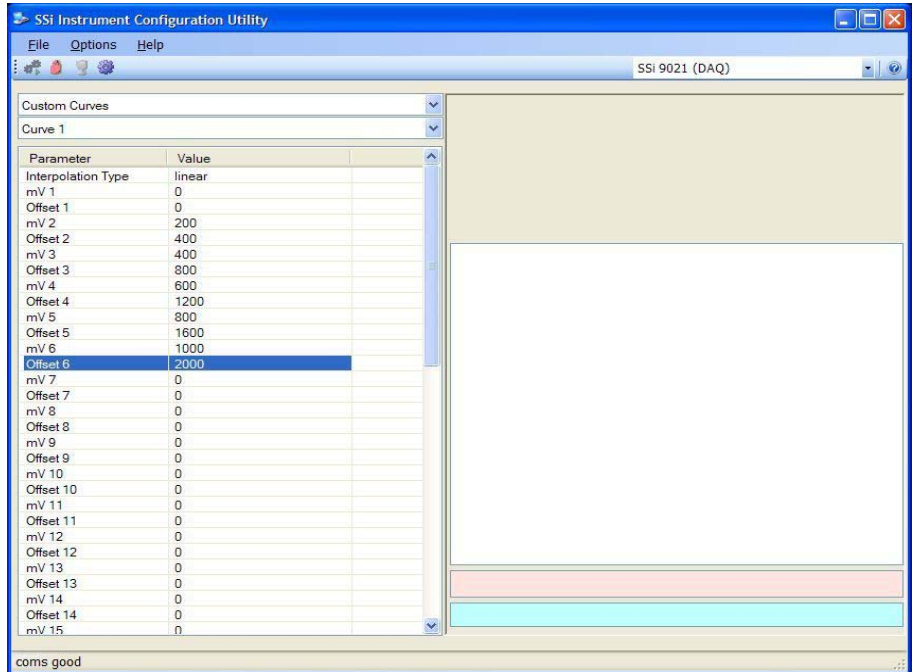

Calibration

The *Calibration* menu option will allow the user to calibrate the inputs on a board. Click on the **click** value to begin the calibration process.

The user will need a thermocouple calibrator capable of outputting a thermocouple signal to calibrate the zero, span or cold junction value of the analog input board. The user will need to connect the calibrator to one of the inputs on the board that will be calibrated. It is recommended to let everything (calibrator and input board) sit for approximately thirty minutes to allow the temperature to achieve equilibrium. Set up the calibrator for the specific thermocouple type of the thermocouples in the analog input board, i.e. type K, type J, etc. Then, source a specific temperature, like 1000 °F, or millivolt to the connected input. It is recommended that the actual temperature used be similar to an appropriate process temperature. For example, if your equipment normally operates at 1700 °F, then perform the cold junction calibration using a 1700 °F signal. It is important to note that when performing a zero or span calibration, *do not use* regular thermocouple wiring. Instead, use any kind of regular sensor wire, or even regular copper wire. To perform the calibrations, the user will need a calibrator that is capable of outputting volts, millivolts, and temperature.

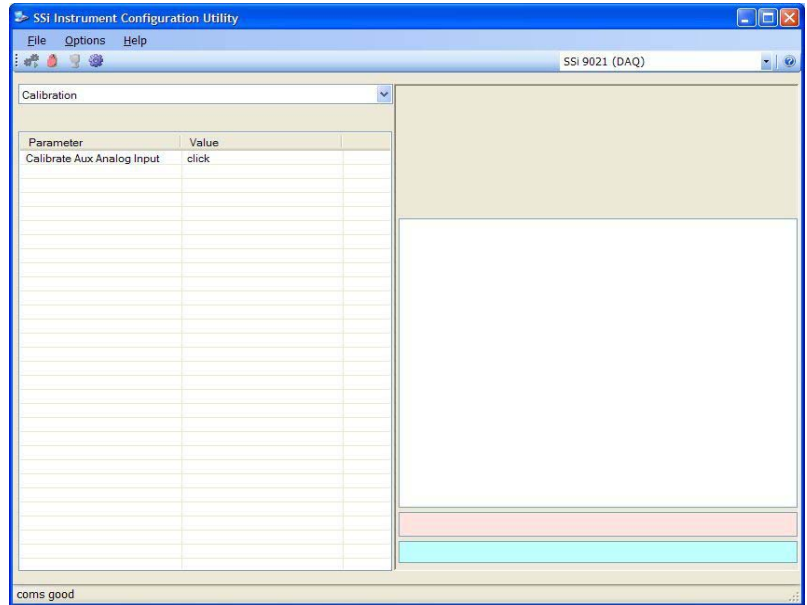

Below is a listing of the suggested ranges for the various TC types.

TC Type mV Range Chart	
TC Type	Range in mV
B	20
C	40
E	80
J	80
K	80
N	80
NNM	80
R	40
S	20
T	20

Zero/Span Calibration

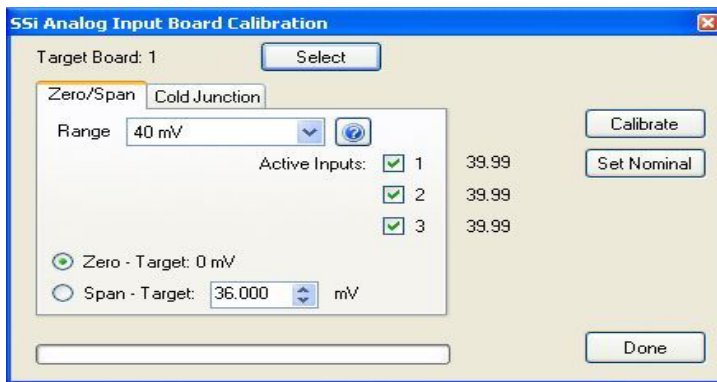

The first step in the calibration process is the zero and span calibration. To select a board to calibrate, click on the **Select** button. This will display a drop-down list that the user can select the board to calibrate. This list will only display the available boards to calibrate. Once a board is selected, the current values will be displayed along the right of the tab box. Select the input range from the drop-down list. To perform a zero calibration, select the "Zero" option. To perform a span calibration, select the "Span" option. The target value for a zero calibration is 0 millivolts. The target value for a span calibration is roughly ninety percent of the range millivolts. The target

value is displayed in the box and can be modified, if desired. If the millivolt range is not known, the user can click on the help button next to the range drop-down list. This will display a list of inputs. Selecting the correct input will set the correct millivolt range.

Checking the check box next to the corresponding input will determine if that input will be included in the calibration.

Note: If the user is using a 10:1 jumper, the user will need to multiply the source signal by 10 to get the correct span value. For example, if the 10:1 jumper is set on a 1.25V range, the suggested source signal will read 1000 mV. The supplied signal will need to be 10000 mV to account for the 10:1 jumper.

For a zero calibration, a value of 0 mV will need to be sourced to the input or inputs.

For a span calibration, a value of 90 % of the full range will need to be sourced to the input or inputs.

Press the **Calibrate** button to begin the calibration process.

Press the **Set Nominal** button to apply nominal values to the inputs.

Cold Junction Offset

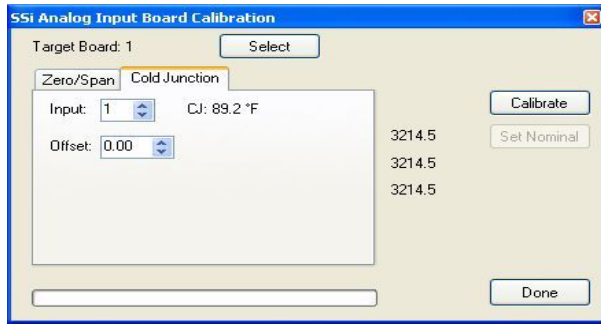

The second step in the calibration process is setting the cold junction offset. If necessary, select a board to calibrate by clicking on the **Select** button. This will display a drop-down list that the user can select the board to calibrate. This list will only display the available boards to calibrate. Select the board's input to apply the cold junction offset to by using the up and down arrows. Select the appropriate offset to use by using the up and down arrows. This can range from **-25.00** to **25.00**. *Note – To subtract a value from the current cold*

junction value, be sure to set the offset value as a minus value by clicking on the plus/minus key on the keypad (+/-). The overall Cold Junction value is modified by adding or subtracting a value to the current value. Press the **Calibrate** button to begin the calibration process.

Press the **Done** button to close out the screen.

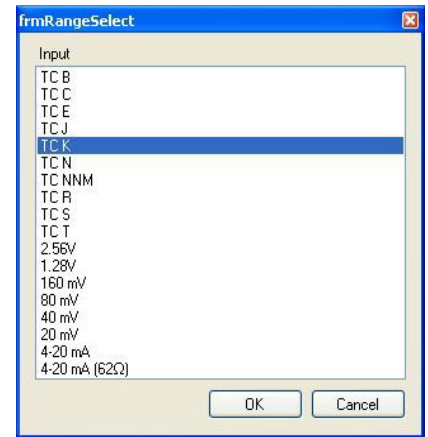

Satellite Boxes – SR3, SR6

The satellite boxes, P/N 13475 (SR3) or 13476 (SR6), represent expandable input slots for the Video Recorders which can be mounted remotely and connected back to the main Video Recorder unit using the RS485 ports. These satellite boxes will give customers the ability to add inputs to the Video Recorder.



The SR3 (pictured) contains three additional inputs for the Video Recorder.

The satellite box SR6 contains six additional inputs for the Video Recorder.

To connect the satellite box back to the main Video Recorder unit, the "Remote RS485" on the satellite box must be wired into the "RS485 Remote" on the main unit. 24VDC need to be provided to the satellite box either by using a jumper from the main VR unit or from a separate source.

DAQ Data Sheets

Serial Number				
IP Address				
Description				
Number of Boards Used				
Notes				
Board #	Input #	Input Type	Furnace Description	Curve
1	1 (1)			
	2 (2)			
	3 (3)			
2	1 (4)			
	2 (5)			
	3 (6)			
3	1 (7)			
	2 (8)			
	3 (9)			
4	1 (10)			
	2 (11)			
	3 (12)			
5	1 (13)			
	2 (14)			
	3 (15)			
6	1 (16)			
	2 (17)			
	3 (18)			
7	1 (19)			
	2 (20)			
	3 (21)			
8	1 (22)			
	2 (23)			
	3 (24)			

Serial Number				
IP Address				
Description				
Board #	Input #	Input Type	Furnace Description	Curve
9	1 (25)			
	2 (26)			
	3 (27)			
10	1 (28)			
	2 (29)			
	3 (30)			
11	1 (31)			
	2 (32)			
	3 (33)			
12	1 (34)			
	2 (35)			
	3 (36)			
13	1 (37)			
	2 (38)			
	3 (39)			
14	1 (40)			
	2 (41)			
	3 (42)			
15	1 (43)			
	2 (44)			
	3 (45)			
16	1 (46)			
	2 (47)			
	3 (48)			

Appendix 1 – Input Number Table

The *Input Values* menu screen (*Configurator Menu* section) displays the boards with the absolute input number, rather than the board input number. For instance, Board 1 has input 1, input 2, and input 3. Board 2 also has input 1, input 2, and input 3. However, each of the inputs also has an absolute number that will range from 1 to 48. For instance, Board 1's absolute input numbers are input 1, input 2, and input 3. But, Board 2's absolute input numbers are input 4, input 5, and input 6. Below is a table listing the board numbers, input numbers, and absolute input numbers.

<u>Board #</u>	<u>Input #</u>	<u>Absolute Input #</u>	<u>Board #</u>	<u>Input #</u>	<u>Absolute Input #</u>
1	1	1	9	1	25
	2	2		2	26
	3	3		3	27
2	1	4	10	1	28
	2	5		2	29
	3	6		3	30
3	1	7	11	1	31
	2	8		2	32
	3	9		3	33
4	1	10	12	1	34
	2	11		2	35
	3	12		3	36
5	1	13	13	1	37
	2	14		2	38
	3	15		3	39
6	1	16	14	1	40
	2	17		2	41
	3	18		3	42
7	1	19	15	1	43
	2	20		2	44
	3	21		3	45
8	1	22	16	1	46
	2	23		2	47
	3	24		3	48

Appendix 2 - Input Ranges

Input Type	Minimum	Maximum
B	32 °F	3308 °F
C	32 °F	4208 °F
E	-328 °F	1832 °F
J	-346 °F	2192 °F
K	-328 °F	2502 °F
N	-328 °F	2372 °F
NNM	0 °F	1409 °F
R	-58 °F	3214 °F
S	-58 °F	3214 °F
T	-328 °F	752 °F
2.56 V	-25600	25600
1.28 V	-12800	12800
160 mV	-16000	16000
80 mV	-8000	8000
40 mV	-4000	4000
20 mV	-20000	20000
4 – 20 mA / 124Ω Using 1:1 jumper	2000	10000
4 – 20 mA / 124Ω Using 10:1 jumper	200	1000
4 – 20 mA / 62Ω Using 1:1 jumper	4000	20000
4 – 20 mA / 62Ω Using 10:1 jumper	400	2000

*** The 4 – 20 mA / 124Ω option is used mainly with the five input boards

*** The 4 – 20 mA / 62Ω option is used mainly with the three input boards

Revision History

Rev.	Description	Date	MCO #
-	Initial Release	7/29/2008	N/A
A	Changed picture formatting to allow text to wrap around; Added "Aux Instruments", "Communication Setup", "Device Configuration", "Aux Instrument Setup" Configurator menus; Modified "Range Setups" Configurator menu; Added sample curve in "Custom Curves" section; Added serial communications setup instructions	12/4/2008	2071